

lovingly  
Crafted



FORMULATE

Flexible Fabric Exhibit Structures

[www.abce Exhibitions.com](http://www.abce Exhibitions.com)

0203 137 2834

[www.abcexhibitions.com](http://www.abcexhibitions.com)

0203 137 2834

## CONTENTS

---

Don't Conform Formulate.	3
Where Form Meets Function	5
Impactful. Easy. Fast.	6
How To Assemble	7
Back Walls	8
Counters	10
Retail Displays	12
Hanging Structures	14
Exhibition Structures	16
Form It Your Way With Accessories	18
Time Saving Solutions	19





[www.abce Exhibitions.com](http://www.abce Exhibitions.com)  
0203 137 2834

## DON'T CONFORM. FORMULATE

---

If you're looking to stand out in a crowd and be noticed, our Formulate products offer an impactful solution in helping you to keep ahead of the competition.

With a large range of standard structures there is plenty to choose from to empower your brand.

Made from strong, yet lightweight tubular aluminium and dressed with a tension fabric graphic, Formulate offers an elegant and engaging portable display solution.

Combining form with fabric, these re-usable, easy to construct products can be mix-and-matched to create your ideal display or exhibit allowing you to "form it your way".

It doesn't stop there - the range also includes custom designed accessories including shelving, lighting and literature holders.







[www.abce Exhibitions.com](http://www.abce Exhibitions.com)  
0203 137 2834

## WHERE FORM MEETS FUNCTION

---

Each structure is manufactured from lightweight, yet strong, aluminium tubing to form a wide range of products available in various widths and configurations. From impressive retail displays through to exhibition and hanging structures, a functional and easy to use product range is available to select from.

We invest in specialist printing and finishing skills to create the best looking and quality finish to each Formulate display product. With a wide range of printing, cutting and finishing techniques including UV, Dye-sub and latex printing, plus digital laser cutting and expert sewing machinists, a top-class professional finish is certain to give your brand the impact it deserves.

We're so confident of the quality, Formulate hardware comes with a five-year guarantee for your peace of mind. As Formulate is all about the fabric, using high quality, high stretch media we can create impressive displays for your needs.

Browse through our catalogue for more information and to see the full standard range. If you can't see what you're looking for, ask us about our custom made solutions which harmonise with any space.

**FIVE  
YEAR**

All Formulate hardware comes with a five year guarantee

# IMPACTFUL. EASY. FAST.

---

We know how important brand impact and ease of use is when looking for a portable display solution. It's why each of our connecting frame sections are clearly labelled with matching symbols making each product easy to assemble.

What's more, certain sections are joined together with a bungee cord saving time compared with other types of display equipment.

The lightweight, yet strong, aluminium tubing makes each product very portable and easy to carry. Each Formulate product is supplied with a carry bag as standard, allowing for easy transportation and storage.

Attaching the graphics is also simple. Each graphic effortlessly slides over the framework and is zipped closed. There is no need to worry about accidentally creasing the graphics as the elasticity within the fabric makes them extremely durable and long-lasting – giving a great return on your investment.

Our high quality fabric graphics are easy to care for – after use, simply zip closed, fold up and place into the bag for future use. As each fabric graphic is machine washable at 30 degrees centigrade, it means your chosen graphic is re-usable and will (with care) look as good as new each time\*.

Whilst quick and easy to put up, there's no compromise on style still delivering impact with its eye-catching shape. The Formulate range offers an impactful, fast and easy to use solution - helping you stand out from the crowd and keep ahead of your competition.

*\* NOTE: Fabric is unsuitable for ironing*



All Formulate products include a carry bag



# HOW TO ASSEMBLE FORMULATE

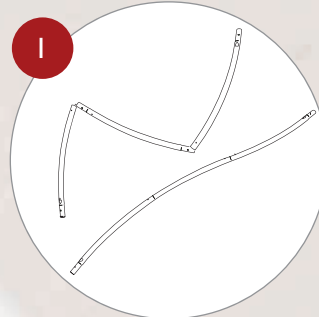

Lay out all components and connect bungee poles.

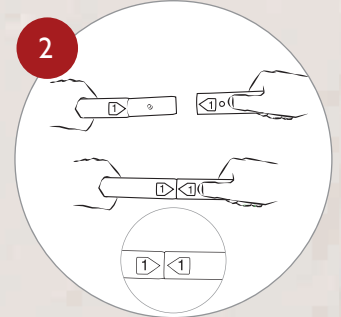

Match the same numbers and colours together.

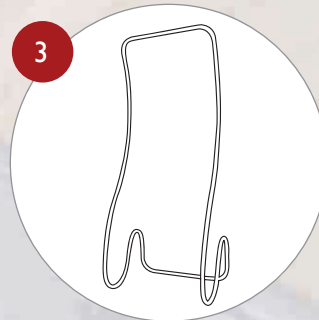

Connect all the parts until you have created the completed shape.

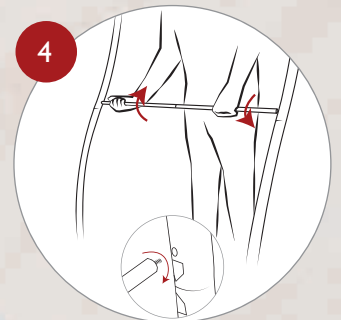

Optional Step - Add support brace when instructed.



Make sure you have a clean surface and hands. Cotton gloves are provided.



Place the fabric graphic sock over the Formulate shape making sure the graphics are the correct way round.

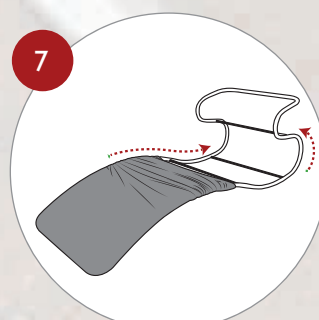

Gently pull graphics completely over the frame until you have a straight snug fit.



Pull the graphics together at the bottom of the tubing and zip up.



# BACK WALLS

Our Formulate back walls are available in a wide range of configurations to set the perfect backdrop for your creation. Whether your space is big or small, the wide choice on offer make it easy to glamorise any space. Design stunning graphics and add accessories to wow your customers.



650 / 955 / 1240 / 1544mm

Plan view



## Monolith Fabric Display

Total hardware dimensions (approx): (h) x (w) x (d) mm

**600mm**  
(FMSS-VSS-01): 2280 x 650 x 250mm

**900mm**  
(FMSS-VSS-02): 2280 x 955 x 250mm

**1200mm**  
(FMSS-VSS-03): 2280 x 1240 x 250mm

**1500mm**  
(FMSS-VSS-04): 2280 x 1544 x 250mm

All Formulate products include a carry bag





⌚  
**Approx.  
 assembly time  
 5-10 mins**



Plan view

### Straight Fabric Display

Total hardware dimensions  
 (approx): (h) x (w) x (d) mm

- 2.4m**  
 (FORM-STR-24): 2280 x 2438 x 480mm
- 3.0m**  
 (FORM-STR-30): 2280 x 3048 x 480mm
- 6.1m**  
 (FORM-STR-61): 2280 x 6096 x 480mm



Plan view

### Curved Fabric Display

Total hardware dimensions  
 (approx): (h) x (w) x (d) mm

- 2.4m**  
 (FORM-CUR-24): 2280 x 2438 x 420mm
- 3.0m**  
 (FORM-CUR-30): 2280 x 3048 x 538mm
- 6.1m**  
 (FORM-CUR-61): 2280 x 6096 x 700mm



Side view

### Vertical Curve Fabric Display

Total hardware dimensions  
 (approx): (h) x (w) x (d) mm

- 3.0m**  
 (FMLT-USS-01): 2280 x 3048 x 583mm



Plan view

### Serpentine Fabric Display

Total hardware dimensions  
 (approx): (h) x (w) x (d) mm

- 3.0m**  
 (FMLT-SSS-02): 2280 x 3048 x 444mm

# COUNTERS

[www.abce Exhibitions.com](http://www.abce Exhibitions.com)

0203 137 2834

Formulate counters couple lightweight hardware with printed stretch silicone edge fabric graphics (SEG) to complete your display or create funky and functional reception stands. Choose from a range of shapes and sizes, or a table top display

## Oval Counter

Total hardware dimensions (approx): (h) x (w) x (d) mm

(FMC-OVA-01): 1015 x 595 x 395mm

Maximum load: 50kg evenly distributed



Approx. assembly time  
**5-10 mins**



595mm

395mm

Plan view

All Formulate products include a carry bag





www.abcexhibitions.com

0203 137 2834

### Rectangle Counter

Total hardware dimensions (approx): (h) x (w) x (d) mm

(FMC-SQA-01): 1015 x 800 x 530mm

Maximum load: 50kg evenly distributed



1015mm



530mm

800mm

Plan view

### Formulate Tabletop

Total hardware dimensions (approx): (h) x (w) x (d) mm

(FMLT-TT-C): 1140 x 1575 x 365mm



1575mm



1140mm

365mm

Side view

### Large Rectangle Counter

Total hardware dimensions (approx): (h) x (w) x (d) mm

(FMC-SQA-02): 1015 x 1880 x 520mm

Maximum load: 50kg evenly distributed



1015mm



520mm

1880mm

Plan view

# RETAIL DISPLAYS

[www.abce Exhibitions.com](http://www.abce Exhibitions.com)  
0203 137 2834

For instant impact in a retail or hospitality environment, we have a choice of free-standing solutions available in different configurations. Add double sided graphics to make sure passers-by see your message from all directions.

## Drum Retail Display

Total hardware dimensions  
(approx): (h) x (w) x (d) mm

(FMDS-3DC-01) 2280 x 2500 x 400mm

⌚  
Approx.  
assembly time  
**12 mins**



400mm  
Side view

**All Formulate  
products include  
a carry bag**



2500mm





Snake  
Retail Display

Total hardware dimensions  
(approx): (h) x (w) x (d) mm

(FMSS-VS-01): 2280 x 915 x 700mm

  
Approx.  
assembly time  
**5-8 mins**



Curl  
Retail Display

Total hardware dimensions  
(approx): (h) x (w) x (d) mm

(FMSS-VS-03) 2280 x 915 x 480mm

# HANGING STRUCTURES

Attract and command attention to your indoor show or event by choosing a Formulate 3-D Hanging Structure to create a strong visual impact. Project your message from all angles and draw attention to your brand with a variety of different structures and shapes to choose from.

## Circle Hanging Structure

Total hardware dimensions (approx): (h) x (dia) mm

- 1.5 x 0.8m (FMHS-RIN-01): 762 x Ø1524mm
- 3.0 x 0.9m (FMHS-RIN-03): 914 x Ø3048mm
- 4.6 x 1.5m (FMHS-RIN-04): 1524 x Ø4572mm



Ø 1524 / 3048 / 4572mm

Plan view



Approx. assembly time  
**10-20 mins**

762 / 914 / 1524mm

**All Formulate products include a carry bag**

*\*Please note suspension cables not included*

[www.abce Exhibitions.com](http://www.abce Exhibitions.com)  
0203 137 2834





1067 / 1219mm

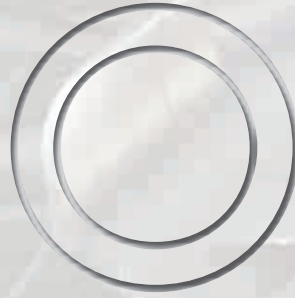

∅ 3048 / 4572mm

Plan view

### Tapered Circle Hanging Structure

Total hardware dimensions (approx): **(h) x (dia) mm**

**3-2.4 x 1.1m**  
(FMHS-TC-01): 1067 x ∅3048-2438

**4.6-3.4 x 1.2m**  
(FMHS-TC-03): 1219 x ∅4572-3962



1219 / 1524mm



3048 / 3658mm

Plan view

838 / 991mm

### Eye Hanging Structure

Total hardware dimensions (approx): **(h) x (w) x (d) mm**

**3.0 x 1.2m**  
(FMHS-EYE-02): 1219 x 3048 x 838mm

**3.7 x 1.5m**  
(FMHS-EYE-03): 1524 x 3658 x 991mm



1067 / 1219mm



2438 / 3048mm

Plan view

2438 / 3048mm

### Square Hanging Structure

Total hardware dimensions (approx): **(h) x (w) x (d) mm**

**2.4 x 1.1m**  
(FMHS-SQU-01): 1067 x 2438 x 2438mm

**3.0 x 1.2m**  
(FMHS-SQU-02): 1219 x 3048 x 3048mm



1219mm



3658mm

Plan view

2438mm

### Rectangle Hanging Structure

Total hardware dimensions (approx): **(h) x (w) x (d) mm**

(FMHS-REC-01): 1219 x 3658 x 2438mm

# EXHIBITION STRUCTURES

Add architecture and design to any event or interior space with a Formulate exhibition structure. Easily create and define a stunning entryway, focal point or meeting space with our eye-catching free-standing arches and meeting pods.

6m  
Arch

Total hardware dimensions  
(approx): (h) x (w) x (d) mm

6m  
(FMLT-ARC-02) 3975 x 6000 x 1000mm



Approx.  
assembly time  
**10-30 mins**

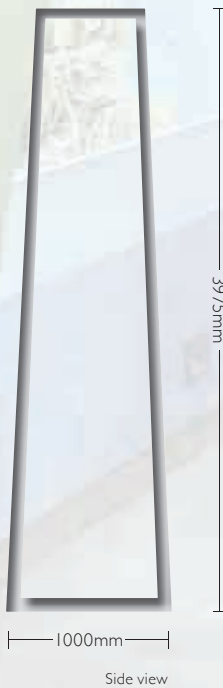

**All Formulate  
products include  
a carry bag**

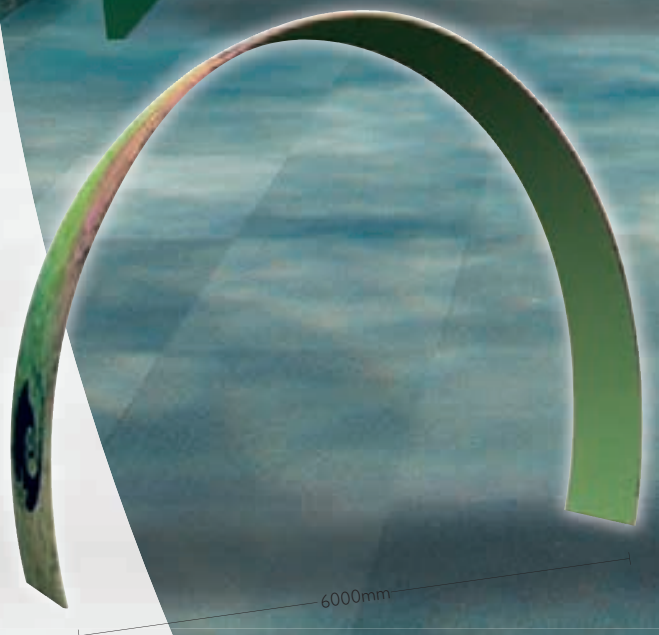





Side view

## 2.7m Arch

Total hardware dimensions (approx): (h) x (w) x (d) mm

**2.7m**  
(FMLT-ARC-01) 2300 x 2700 x 1000mm

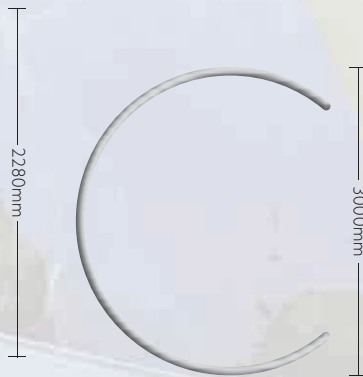

Plan view

## Meeting Pod

Total hardware dimensions (approx): (h) x (w) x (d) mm

(FMLT-SC-01) 2280-1219 x 3000 x 2495mm



Side view

## 6m Arch (Triple)

Total hardware dimensions (approx): (h) x (w) x (d) mm

**6m**  
(FMLT-ARC-03) 3975 x 6000 x 5000mm

# FORM IT YOUR WAY WITH ACCESSORIES

FMLT 158-32  
Formulate clamp  
32mm diam. Pole



FX839  
Literature holder  
bracket

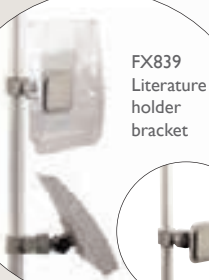

Available in:  
A5, A4 & DL

FX867  
Tablet holder  
bracket†



†Suitable for all iPads  
except the mini iPad

FX838  
Shelf  
bracket



1.5kg approx. evenly distributed  
More than one shelf can be used\*

\*Caution: Overloading may cause instability.  
Always check that the stand is stable before  
adding additional accessories

Accessorise your Formulate display with our specially designed accessory kit, allowing you to add shelving, tablets and literature.

## Fitting the Universal Accessory and Clamp

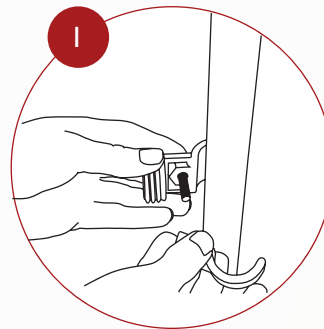

1  
Position clamp  
around tubing.

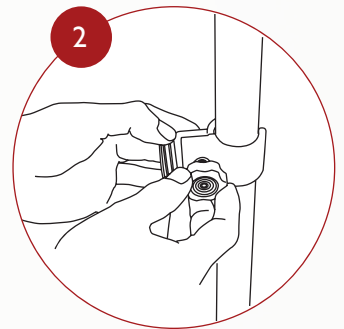

2  
Once in desired place tighten  
with the thumb wheel.

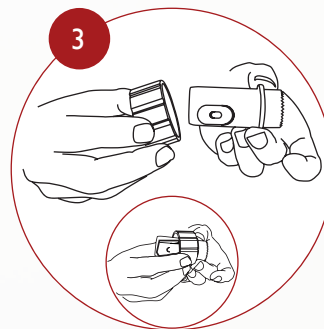

3  
Put the collar through  
the fitting insert.

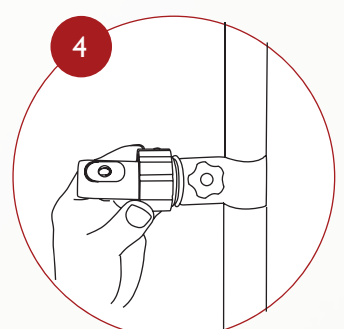

4  
Tighten the collar to  
the clamp as shown.

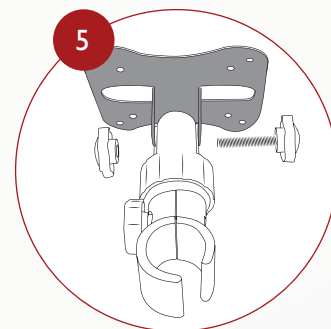

5  
Attach to the Universal Clamp by aligning the holes of  
the bracket onto the holes on the insert moulding then  
tighten with black thumb wheel. Adjust to suit.



# TIME SAVING SOLUTIONS

We understand that when planning an event or exhibition your time is precious with potentially multiple suppliers to manage. With our single source supply solution, why not trust us to deliver both your product and printing requirements as a complete solution. With our state of the art printing capabilities and expert sewing and finishing teams we can save you time allowing you to concentrate on the finer details.

To help you further, we've created more time saving solutions with a choice of coordinated exhibition collections to choose from. With products selected from our most popular selling products, our **"FORM IT UP!"** packages offer impact and choice to work within your chosen space:



**FORM IT UP! - Mini**  
Snake display  
Oval counter  
1.5m monolith



**FORM IT UP! - Midi**  
3m curved fabric display  
900m monolith  
Rectangular counter



**FORM IT UP! - Maxi**  
6.1m straight fabric display  
Monolith 1.5m  
Rectangular counter

With consistent graphics (fabric and colour), cost savings and in-house production, our **FORM IT UP!** Packaged solutions deliver quality products for effective marketing of your brand. Ask your dealer for more information.



Laser cutting



Dye-sub, UV, latex and screen printing available



[www.abce Exhibitions.com](http://www.abce Exhibitions.com)

0203 137 2834